

10 9 8 7 6 5 4 3 2 1

REV	DATE	DESCRIPTION
A	01/03	REDRAWN ON CAD

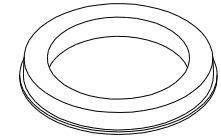

ISOMETRIC VIEW
SCALE 1:1

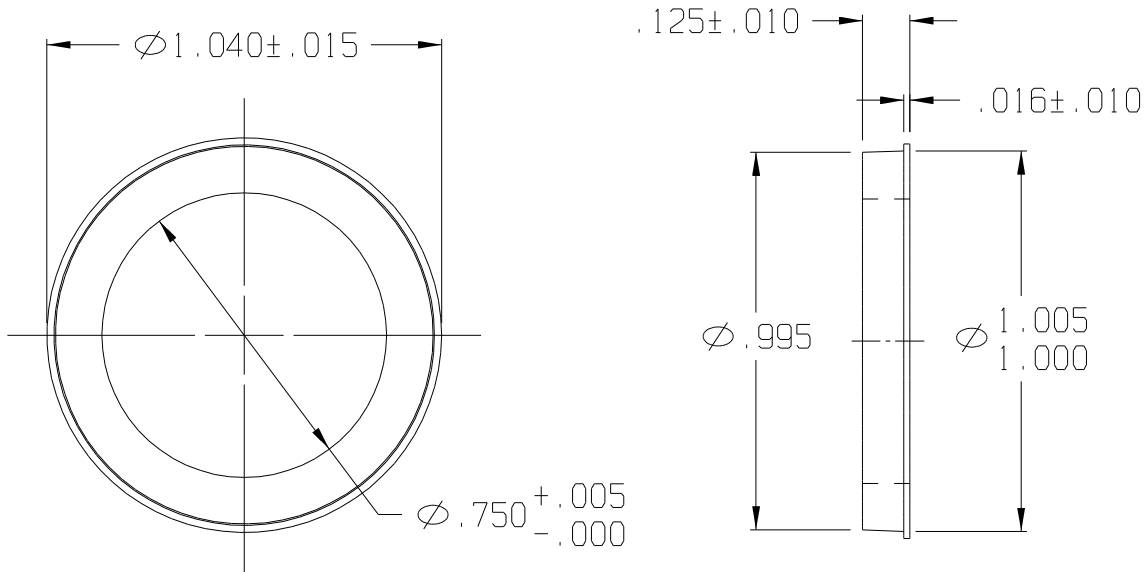

F:\CADKEY\AUCILLA BEARING\PART PRINTS\API 0697_A

THIS DOCUMENT CONTAINS PROPRIETARY DESIGNS, SPECIFICATIONS, DATA, INFORMATION AND TECHNICAL MATERIAL THAT ARE THE SOLE PROPERTY OF AUCILLA, INC. THIS INFORMATION IS TO BE HELD AND TREATED BY ITS RECIPIENT ON A CONFIDENTIAL BASIS, AND IS NOT TO BE SHOWN OR DISCLOSED TO THIRD PARTIES WITHOUT THE WRITTEN CONSENT OF AUCILLA INC. THIS DATA DOES NOT CONVEY MANUFACTURING RIGHTS TO ANY ITEM SHOWN.



STANDARD TOLERANCES APPLY UNLESS OTHERWISE NOTED	
LINEAR INCH	ANGULAR
4 PLACE ± -----	4 PLACE \ -----
3 PLACE ± .010	3 PLACE \ -----
2 PLACE ± -----	2 PLACE \ -----
1 PLACE ± -----	1 PLACE \ -----
WHOLE ± -----	WHOLE \ -----

DESCRIPTION FLANGED WASHER			
PART NO. SH-2	API NO. 0697	SCALE: 2:1	REV. A
MATERIAL: Delrin 500P NC10	DRAWN BY: Dittrich	DATE: Jan. 2003	

10 9 8 7 6 5 4 3 2 1